

Modifiable coat rack for public lobbies and foyers

LobbyTech

- You can change the dimensions and configure the structures to suit your space
- The range of available materials and colours ensures that the coat rack always suits the environment
- You can also get LobbyTech with no glass
- You can add more functionalities with accessories.
- The series includes coat rack systems for public premises, offices, schools and day care centres, as well as compatible shoe racks, seats, vertical coat racks and wall-mounted coat racks
- All Lobby products are manufactured in Finland

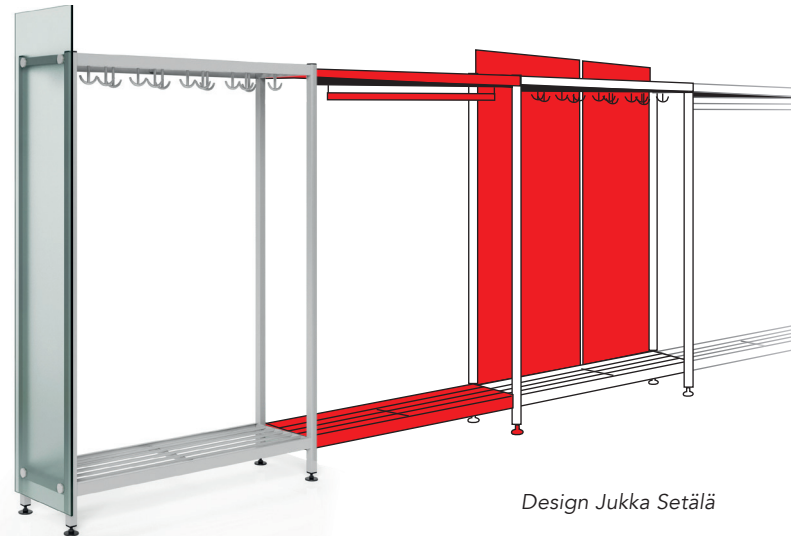

More details in colour table

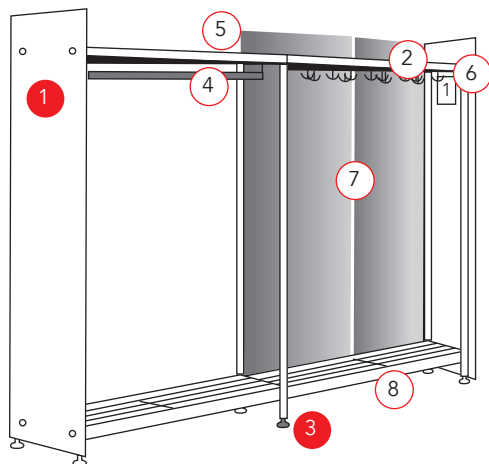

Design Jukka Setälä

LobbyTech- rack system



basic section  additional section 

The rack system is a part of the Lobby product family. The product family includes Lobby, -Tech, -Kid, -Junior, -Seat, -Boot, -Wall, -Wall Boot and -Lite racks.

More details
in colour and
dimensioning
table

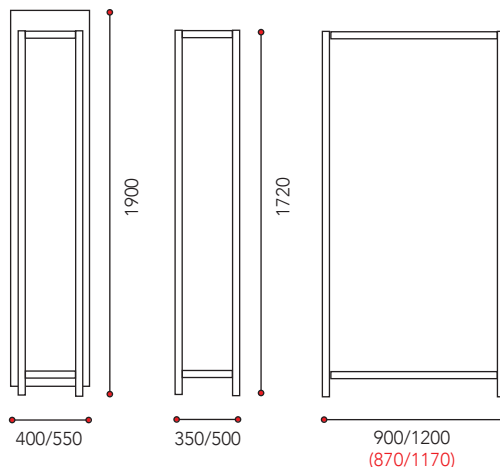



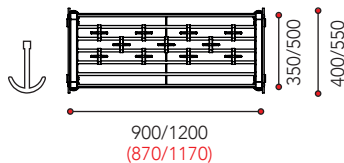



- 1 Ends**
- laminated glass
- metal frame



- 2 Shelves and hooks**
- shelves coatpainted steel
- fiberglass reinforced hooks

Accessories

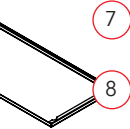
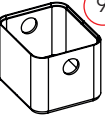
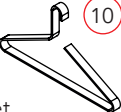
-  **2** Metal hooks painted / chrome
-  **3** Castor, only for 550/500 depth
-  **4** Hanger rail painted/ chromed metal
-  **5** Wall mounting (can't be used with back panel)
-  **6** Coat tag
-  **7** Back laminated glass
-  **8** Dirt protector
-  **9** Loota-storage box, big
- 3 pcs 900 wide
- 4 pcs 1200 wide
-  **10** Hangeri-henger
- 6 pcs 900 wide
- 9 pcs 1200 wide

- 3 Feet**
- adjustable feet